



Vehicle identification

SPECTRE Access UHF RFID reader

APPLICATION NOTE



Contents

1	General principles of UHF technology.....	4
1.1	How it works.....	4
1.2	Uses and limitations, environmental effects, tips.....	4
1.3	Optimal orientation.....	5
1.4	Installations: the basic rules.....	6
1.5	Positioning the tags.....	7
1.6	Athermic windshields.....	8
2	SPECTRE range.....	9
2.1	ANT_UHF2.....	9
2.2	SMA.....	9
2.3	SLA.....	9
2.4	CAB_SPECTRE.....	9
3	Hybrid UHF SPECTRE and URx installation.....	10
3.1	Powers.....	10
3.1.1	Table of URD powers.....	10
3.1.2	Table of URC2 powers.....	11
3.2	Details of the connectors.....	12
3.3	Hybrid system with a URD or URC2 reader.....	13
3.4	Hybrid system with a SPECTRE reader.....	14
4	RSSI filtering.....	16
4.1	Introduction.....	16
4.2	Example.....	16
5	Input/output parameters.....	18
5.1	Introduction.....	18
5.2	Inputs.....	18
5.3	Outputs.....	19
5.4	Example: reading activated when the presence of a vehicle is detected.....	21
5.4.1	ULTRYS v2 settings.....	21
5.4.2	Connection.....	21
5.4.3	Operation.....	21
5.5	Example: Activation of an external optical warning.....	22
5.5.1	ULTRYS V2 settings.....	22

5.5.2	Connection	23
5.5.3	Operation	23
6	Approach to projects.....	24
7	Examples of configurations	25
7.1	One-lane single access	25
7.2	One-lane single access – Double height.....	26
7.3	Single Entrance / Exit for light vehicles only with a central island.....	27
7.4	Double-width access on a two-way public road	28
7.5	Multiple-lane access.....	29
8	Installation methodology	30
9	Athermic windshields.....	31
10	FAQ.....	32
11	VERSION	33

1 General principles of UHF technology

1.1 How it works

Passive RFID applications are authorized in the range from 860 MHz to 960 MHz. The precise limits vary from one country to another. The two main frequency bands are 865-868 MHz and 902-928 MHz.

Depending on the power of the reader, the gain and the directivity of its antenna, and the characteristics of the tag to be read, the actual range of a passive UHF RFID system can extend from about 10 centimeters to about 10 meters.

1.2 Uses and limitations, environmental effects, tips

Certain physical rules apply to this technology that can influence operation and performance in terms of distance and speed.

The following salient points should be kept in mind.

- The influence of the materials on which or behind which the tag is used. Tags must be adapted to their environment in order to produce the best results.
- At this frequency, waves do not pass through liquids well. Human bodies between the reader/antenna can form an obstacle that prevents the tag from being read.
- Radiofrequency identification does not work through metals (problem with athermic windshields or armored vehicles).
- The waves are frequently reflected on the surface of objects (metal, concrete, the ground, etc.) and the presence of obstacles in the read field can influence the results.
- UHF technology can be directive and systems are installed according to the read zone of the antenna and its characteristics.
- A UHF tag can also have a direction linked to the polarization of its antenna. "Linear" tags are susceptible to their direction and are better read horizontally than vertically, for example.

1.3 Optimal orientation

In view of the above-mentioned factors, it is preferable to find the conditions of implementation that optimize system performance, i.e., the best possible position between the antenna and the tag.

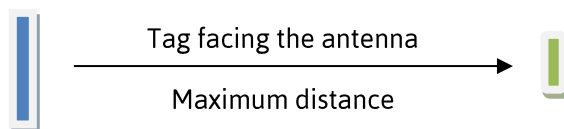

The distances in the technical specifications of readers are measured facing the reader, with the tag parallel to the antenna.

An angle may be formed horizontally or vertically, depending on:

- the height of the antenna relative to the vehicle,
- the offset of the antenna on the side relative to the road.

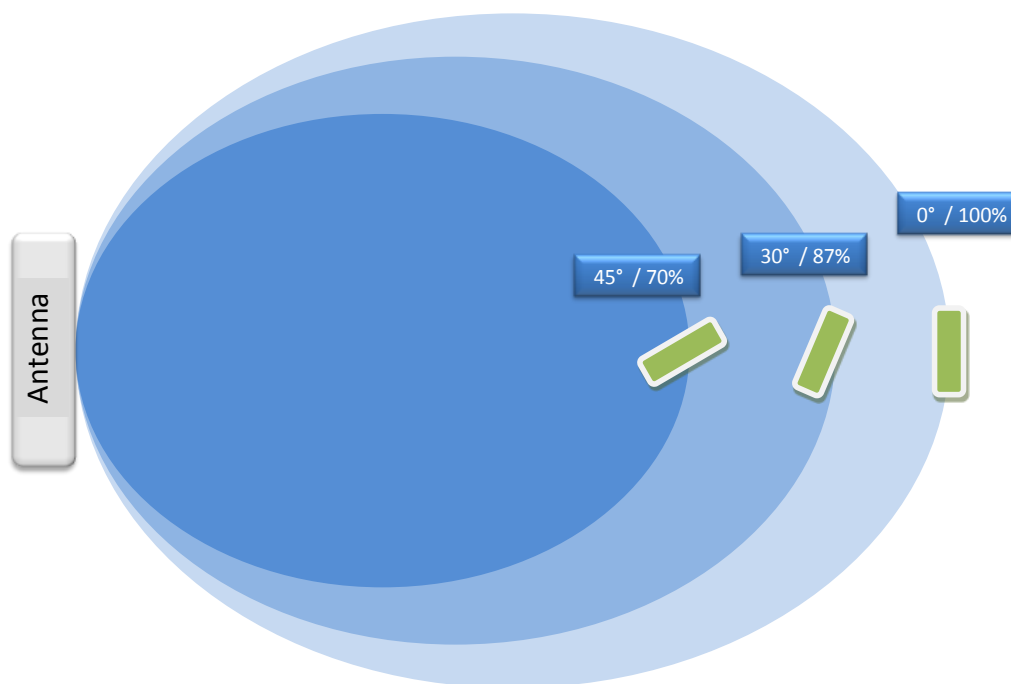

1.4 Installations: the basic rules

It is advisable to position the antenna and to determine the detection zone **before** the barrier. This will make detection more reliable and leave the system time to open the barrier.

Make sure there are no obstacles (barrier, totem, etc.) between the tag and the antenna.

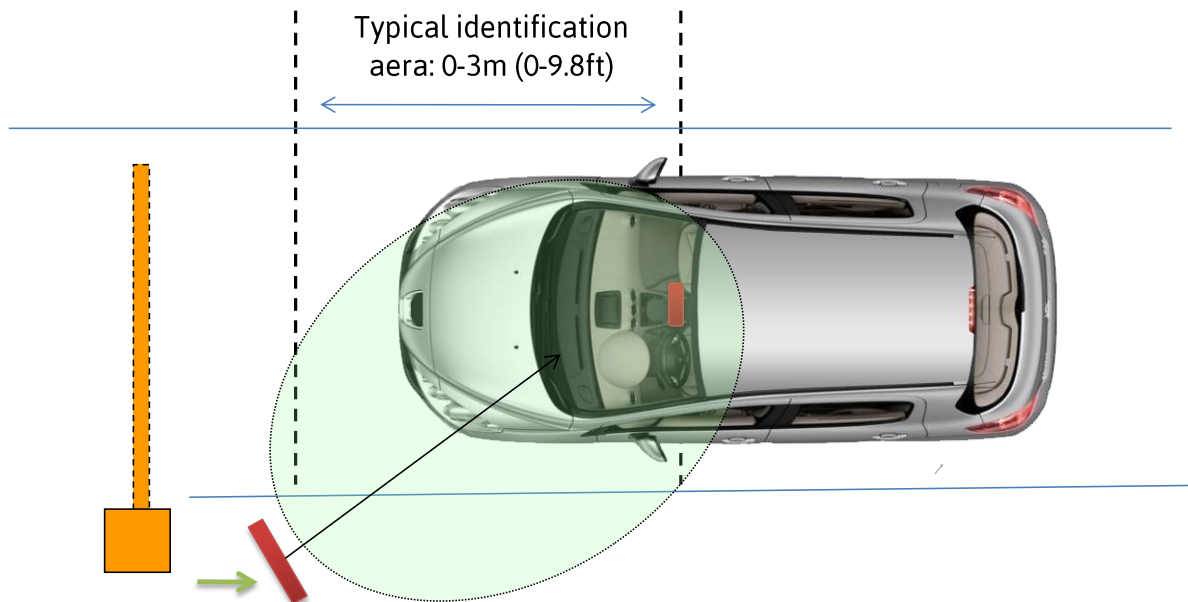

Installing the antenna at height allows it to be directed downwards in order to limit the reading distance on the ground and to avoid the unwanted detection of a second vehicle.

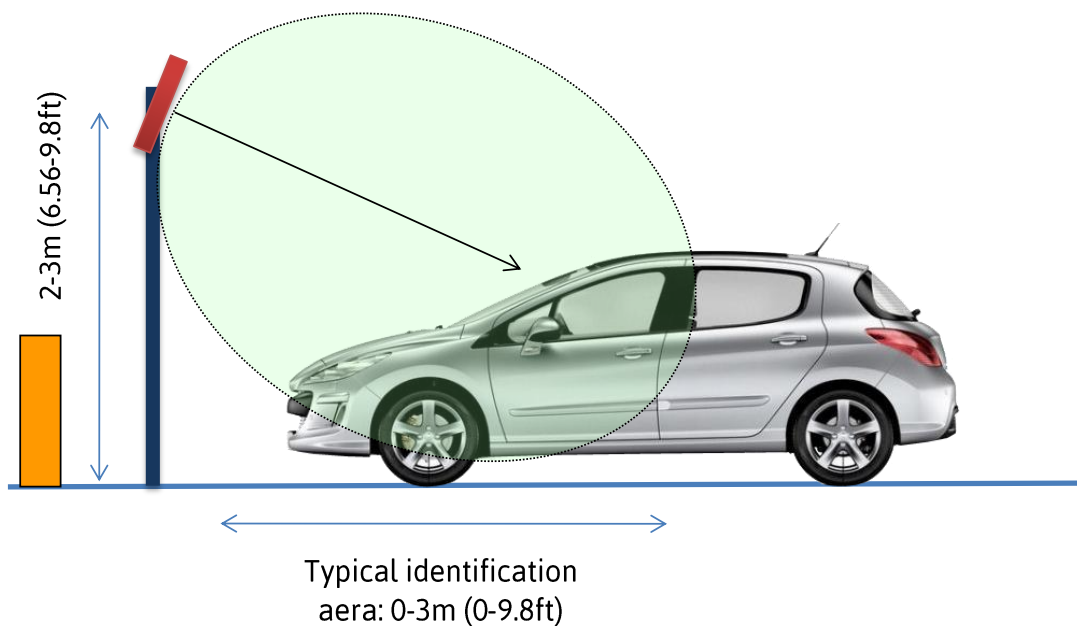

1.5 Positioning the tags

The position of the hardened TeleTag® or the ETA label on the windshield affects the performance and depends on the type of windshield.

Goal: to position the tag for optimal quality/performance of reading.

Standard light vehicles

Put the tag at the top of the windshield, behind the central rear view mirror, and on the side where the reader antenna is, if possible. Position the tag so that it does not adhere to the upper edge of the windshield.



Choose the side according to the position of the antenna / reader

Heavy vehicles / trucks / buses

There are two solutions:

- a TeleTag® model (TLTA) interior tag or an ETA tag on the windshield. The rules for positioning the tag are the same as for light vehicles.
- an exterior tag for metal supports installed on the bodywork. Put the tag in a position where it is as parallel as possible to the reader antenna and in the required reading zone.

Installing the TeleTag®

Once you have chosen the position, install the tag using the support provided.

- Insert the tag using the method of your choosing:
 - You can take the TeleTag® out of its support and keep it with you or install it on another vehicle.
 - The TeleTag® is permanently fixed.



- Fix the support horizontally to the windshield using the two-sided adhesive strips provided.

Caution: in view of the angle of certain windshields, remember to leave enough room to insert the tag in the support when choosing a position.

1.6 Athermic windshields

Athermic windshields are made of sheets of metal in order to partially reduce the heat inside the vehicle's passenger compartment.

Athermic windshields can be recognized by the reflections on the glass.



Impact of athermic windshields on operation

Athermic windshields influence the performance of the system, because the metal blocks the radio waves. Most athermic windshields have a non-athermic section (see the non-exhaustive list in the Appendix). This section is intended for radio-based systems (GPS, toll payment badges, RFID, etc.). On the other hand, the reading distances may be shorter.

Therefore, it is important to take this parameter into consideration before installing and to proceed with tests in order to find the right position for the readers

2 SPECTRE range

2.1 ANT_UHF2



Antennas for SMA and SLA.

2.2 SMA



SPECTRE Access Module.
Possibility to connect up to four remote antennas.

2.3 SLA



SPECTRE Access Reader = SMA + ANT_UHF2.
Possibility to connect up to three remote antennas.

2.4 CAB_SPECTRE

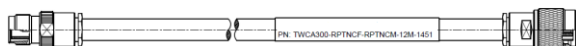

The antenna cables are fitted with a module connector and an antenna connector (label on the antenna side of the cable)

Available cables:

Length	Reference	Colored label on the cable
1.5 m	CAB-SPECTRE-1.5M	TECHNIWAVE PN: TWCA195-RPTNCF-RPTNCM-1.5M-1448
3 m	CAB-SPECTRE-3M	TECHNIWAVE PN: TWCA195-RPTNCF-RPTNCM-3M-1449
9 m	CAB-SPECTRE-9M	TECHNIWAVE PN: TWCA240-RPTNCF-RPTNCM-9M-1450
12 m	CAB-SPECTRE-12M	TECHNIWAVE PN: TWCA300-RPTNCF-RPTNCM-12M-1451

The cables can be serial-connected for intermediate lengths:



Length	Reference
3 m	CAB-SPECTRE-1.5M + CAB-SPECTRE-1.5M
4.50 m	CAB-SPECTRE-1.5M + CAB-SPECTRE-3M
6 m	CAB-SPECTRE-3M + CAB-SPECTRE-3M
10.5 m	CAB-SPECTRE-1,5M + CAB-SPECTRE-9M
12 m	CAB-SPECTRE-12M

3 Hybrid UHF SPECTRE and URx installation

3.1 Powers

The maximum power of the UHF readers must not be exceeded.

The power setting depends on the cables and antennas used.

In hybrid installations with a URx reader, the configuration of the reader must be modified with Ultrys V1 to adapt the power to the new hardware and comply with the applicable regulations.

The drop-in power depends on the new cables used.

3.1.1 Table of URD powers

Modification of the power in Ultrys V1: one single RF power field applies to the antennas.

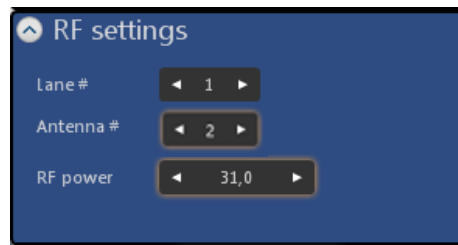
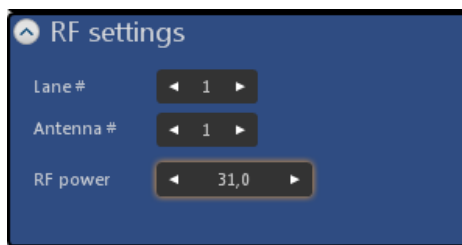

	ETSI (R4x)	FCC (R5x)
URD + CAB_URD + ANT-URD (power by default)	31 dBm	30.5 dBm
URD + CAB_URD + ANT_SPECTRE	28 dBm	27.5 dBm
URD + CAB_SPECTRE + ANT_URD	31 dBm	30.5 dBm
URD + CAB_SPECTRE 1.5 or 3m + ANT_SPECTRE	31 dBm	30.5 dBm
URD + CAB_SPECTRE 9 or 12m + ANT_SPECTRE	29.7 dBm	29.3 dBm

3.1.2 Table of URC2 powers

Modification of the power in Ultrys V1. One power field for the integrated antenna and one for the remote antenna.









	ETSI (R4x)	FCC (R5x)
Power of the integrated antenna	On the adhesive label on the reader 	30 dBm

Power of the remote antenna	ETSI (R4x)	FCC (R5x)
URC2 + CAB_URD + ANT_URD (power by default)	31 dBm	30.5 dBm
URC2 + CAB_URD + ANT_SPECTRE	28 dBm	27.5 dBm
URC2+ CAB_SPECTRE + ANT_URD	31 dBm	30.5 dBm
URC2 + CAB_SPECTRE 1.5 or 3m + ANT_SPECTRE	31 dBm	30.5 dBm
URC2 + CAB_SPECTRE 9 or 12m + ANT_SPECTRE	29.7 dBm	29.3 dBm

Modification of the power in Ultrys V1. The power of the integrated antenna remains unchanged. Only the RF power of the remote antenna may have to be changed.

3.2 Details of the connectors

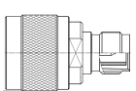
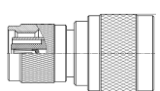
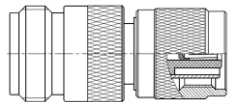
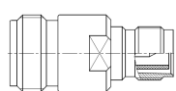
Hardware / Type of connector			
<p>URD or URC2</p>  <p>Connector N male</p>	<p>CAB_URD</p>  <p>Connector N female</p>	<p>ANT_URD</p>  <p>Connector N male</p>	
<p>SMA</p>  <p>Connector TNC female</p>	<p>CAB_SPECTRE</p>  <p>Connector TNC male</p>	<p>ANT_UHF2</p>  <p>Connector TNC male</p>	
<p>ADAPT-URD-ANT2</p>  <p>Connector N female</p>	<p>Connector TNC female</p>	<p>ADAPT-SMA-ANT-URD</p>  <p>TNC male connector</p>	<p>Connector N male</p>
<p>ADAPT-SMA-CAB-URD</p>  <p>Connector N female</p>	<p>Connector TNC male</p>	<p>ADAPT-CAB-URD-ANT2</p>  <p>N female connector</p>	<p>Connector TNC female</p>

3.3 Hybrid system with a URD or URC2 reader

Initial installation

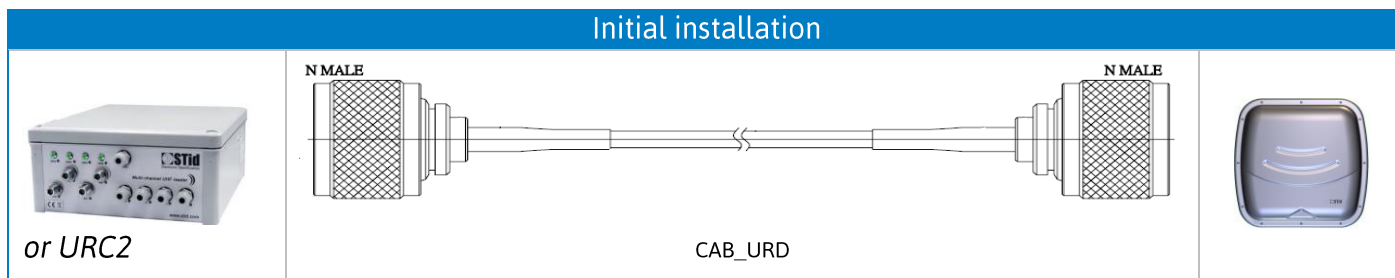

Replacement: ANT_URD by ANT_UHF2

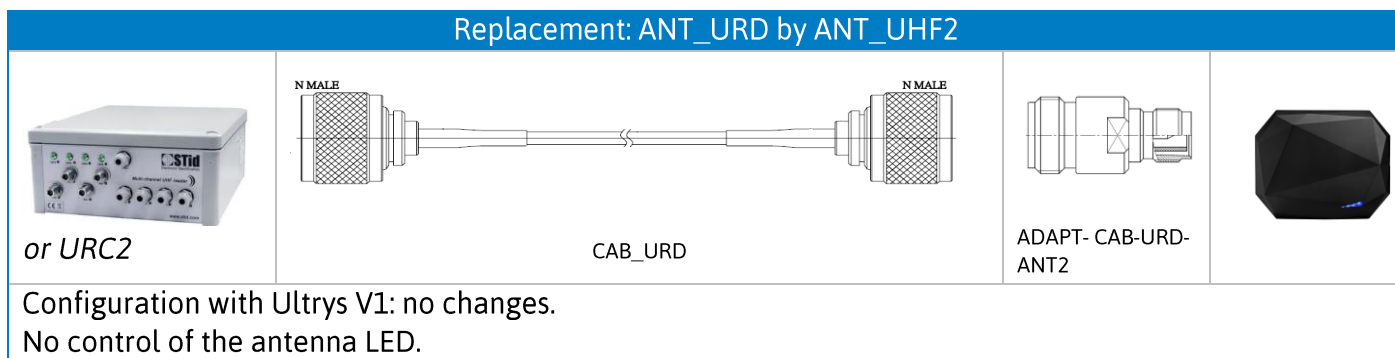

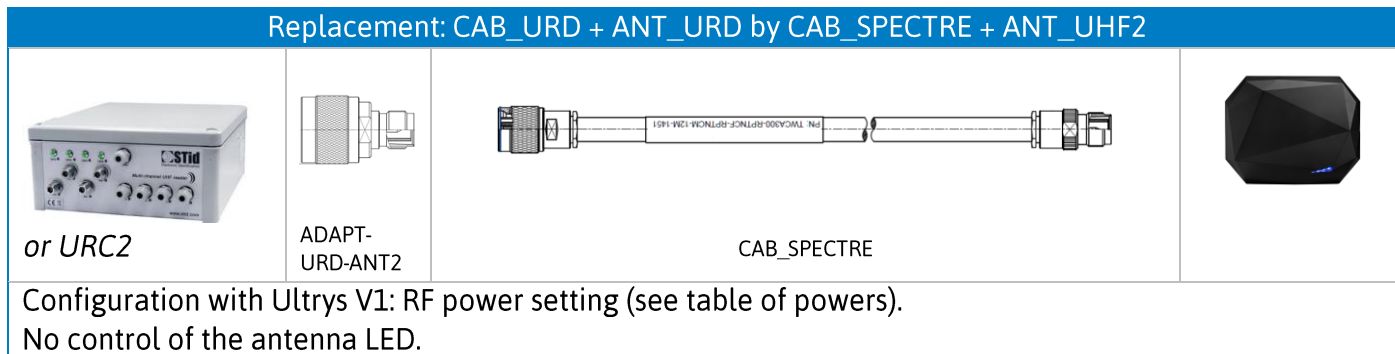

Replacement: CAB_URD + ANT_URD by CAB_SPECTRE + ANT_UHF2

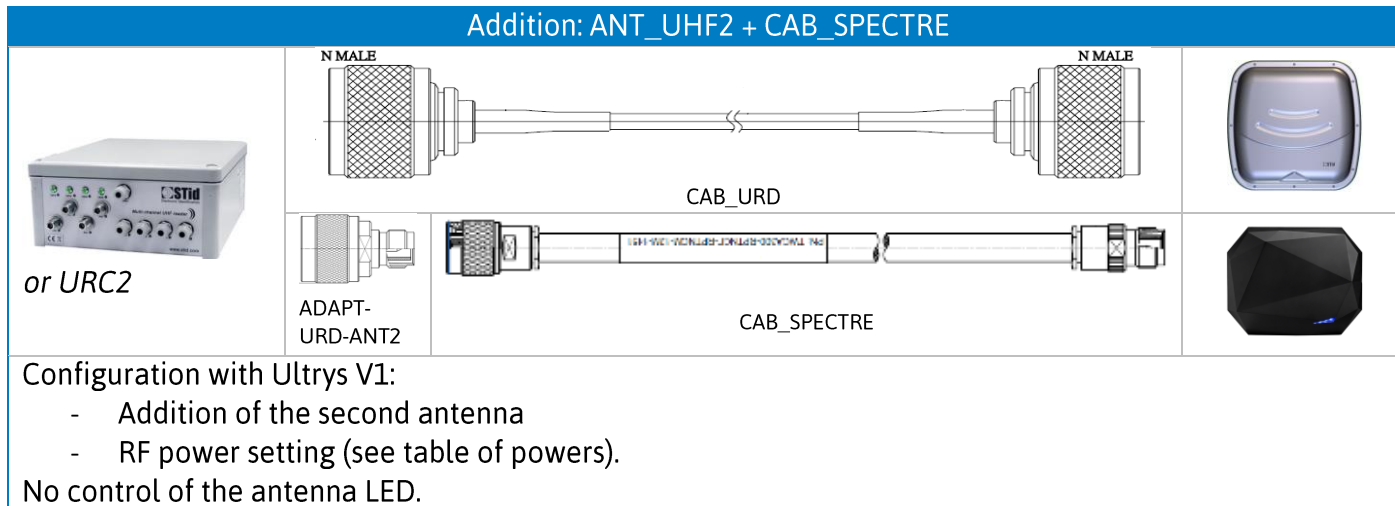

Addition: ANT_UHF2 + CAB_SPECTRE



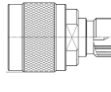
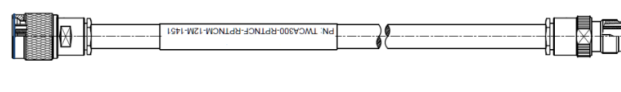
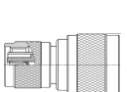

Replacement: CAB_URD by CAB_SPECTRE

 or URC2	 ADAPT-URD-ANT2	 CAB_SPECTRE	 ADAPT-SMA-ANT-URD	
Configuration with Ultrix V1: no changes.				

3.4 Hybrid system with a SPECTRE reader

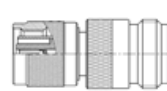
SMA + CAB_URD + ANT_URD

	 ADAPT-SMA-CAB-URD	 CAB_URD	
---	--	---	---

Configuration with Ultrix V2
Step 4: Select "URD antenna"



Step 5: Select "URD cables"



SMA + CAB_URD + ANT_SPECTRE

	 ADAPT-SMA-CAB-URD	 CAB_URD	 ADAPT-CAB-URD-ANT2	
---	--	---	---	---

Configuration with Ultrix V2
Step 4: Select "SPECTRE antenna"



Step 5: Select "URD cables"



SMA + CAB_SPECTRE + ANT_URD

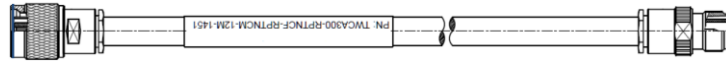

CAB_SPECTRE

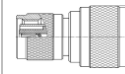

ADAPT-SMA-ANT-URD



Configuration with Ultrys V2 Step 4: Select "URD antenna"



Step 5: Select the length of the SPECTRE cable



4 RSSI filtering

4.1 Introduction

RSSI, or “Received Signal Strength Indication”, is a measurement of the strength of the response received from the tag. The value sent by the reader is proportional to the amplitude of the received signal.

4.2 Example

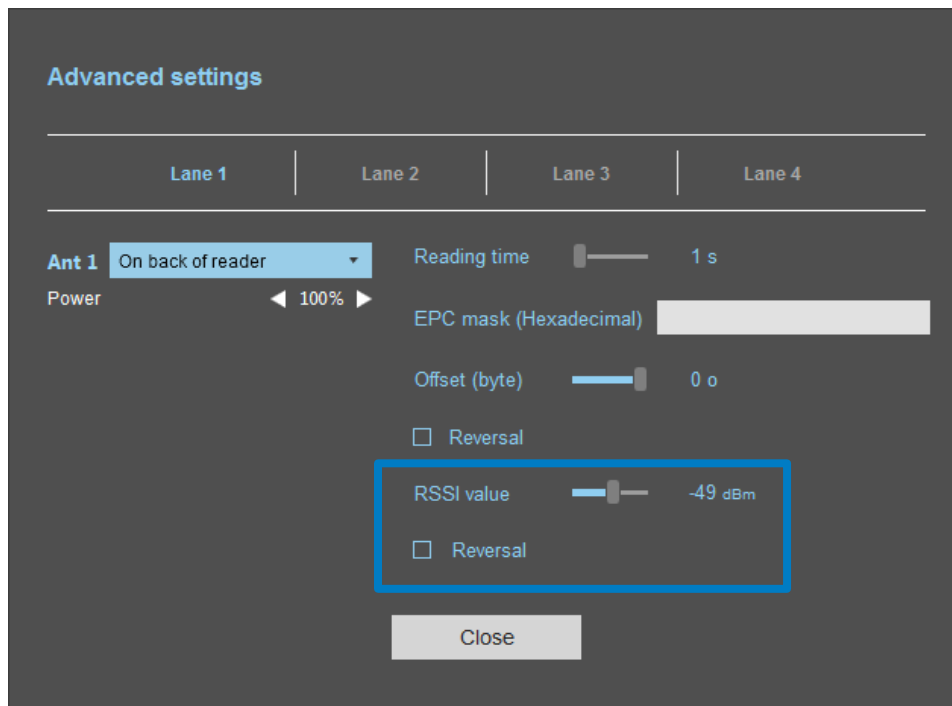

Tags with an RSSI higher than -49dBm are sent to the system. The others are not.

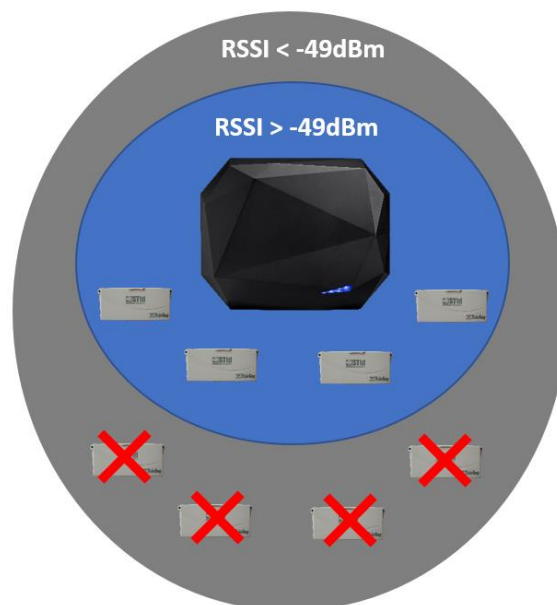

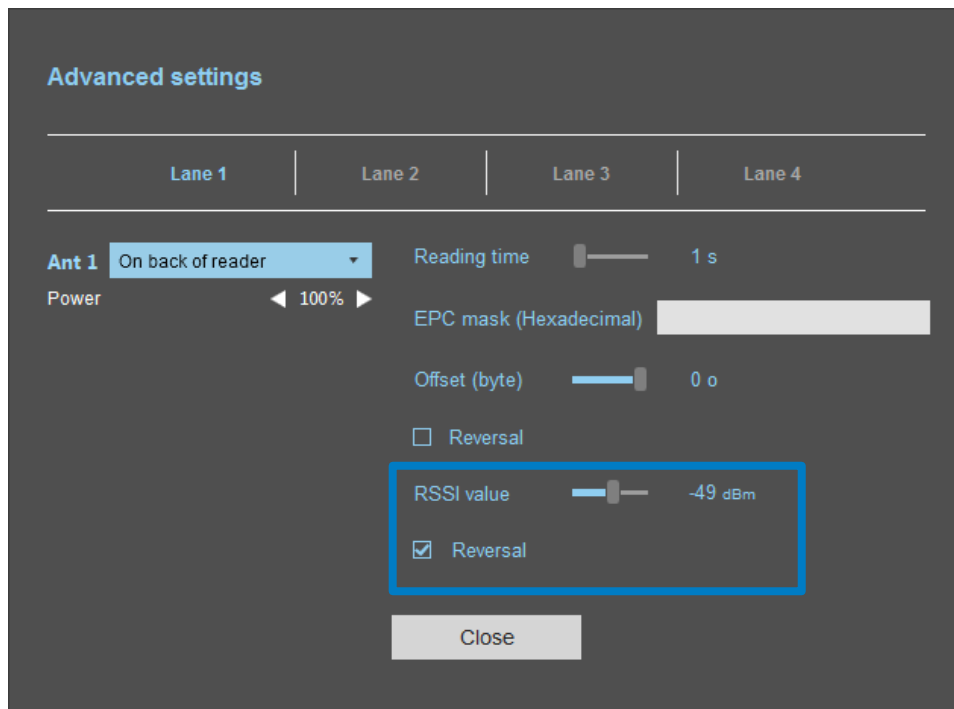

When “Inversion” is activated, tags with an RSSI lower than -49dBm are sent to the system. The others are not.



5 Input/output parameters

5.1 Introduction

SPECTRE readers are fitted with four octo-coupled inputs (INx) and outputs (OUTx).

Therefore, the readers allow:

- the activation of the reading to be configured. For example, using a photoelectric barrier or a detection loop on the ground.
- an action to be taken at the reader outputs, for example by reading specific labels.

Their operation can be configured using the ULTRYS V2 software.

The reader checks the inputs every 50 ms. When an input is detected, the reader takes the configured action and continues to check the other inputs.

5.2 Inputs

By applying a potential to IN that induces a minimum difference in potential of 3.3 Vdc between IN and V+ ($V_+ - V_{IN} > 3.3\text{ V}$), the transistor turns on (switch closed), and the information indicating the presence of a signal at the input is transmitted to the reader. If no potential is applied to the IN input, the transistor is blocked (switch open).

Caution: the polarization voltage V+ depends on the voltage available on the IN of the external system. For activation, $3.3\text{ Vdc} \leq V_+ - V_{IN} \leq 36\text{ Vdc}$.

<p>IN input active</p>		<p>Switch closed</p>
<p>IN input inactive</p>		<p>Switch open</p>
<p>Connection</p>		

5.3 Outputs

The outputs behave like open/closed switches. The rest state is configured using the ULTRYS V2 software. A normally open output will be closed by the action of the reader and vice versa (refer to the ULTRYS V2 User Manual).

Depending on the chosen option, the output will be connected to an internal pull-up (pull-up to V+) or left unconnected (collector open).

Caution: DO NOT CONNECT THE OUT OUTPUTS TO V-

PULL-UP TO V+		
<p>ULTRYS V2 settings Pull up to V+</p>		
<p>Operating diagram Pull up to V+</p>		<p><u>Level 0 output:</u> $V_{OUT} = V-$</p> <p><u>Level 1 output:</u> $V_{OUT} = V+$</p>
<p>Connection of the pull up to V+</p>		

COLLECTOR OPEN

ULTRYS V2 settings
Collector open

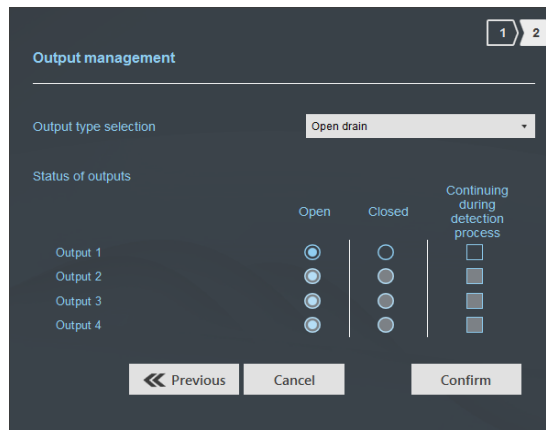

Operating diagram
Collector open

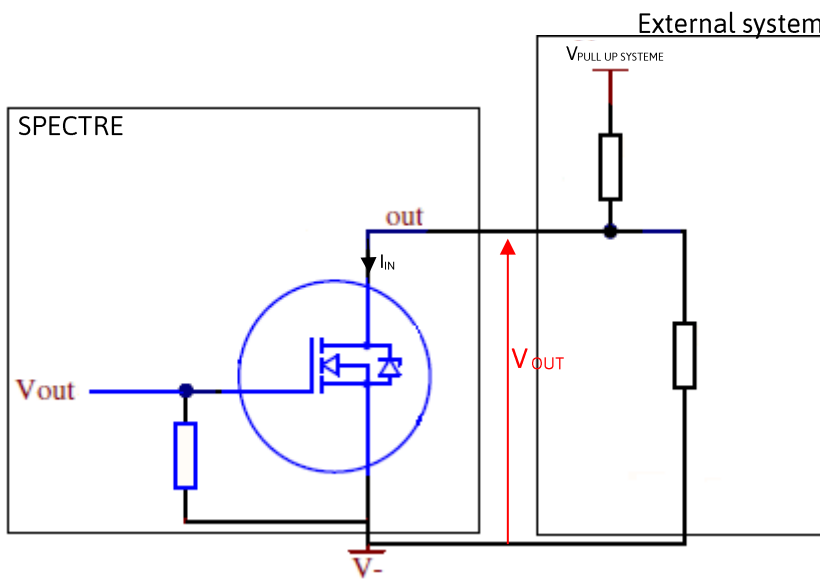

Level 0 output:

$$V_{OUT} = V-$$

Level 1 output:

$$V_{OUT} = V_{PULL\ UP\ SYSTEM}$$

CAUTION: I_{IN} max 200mA

Collector open connection

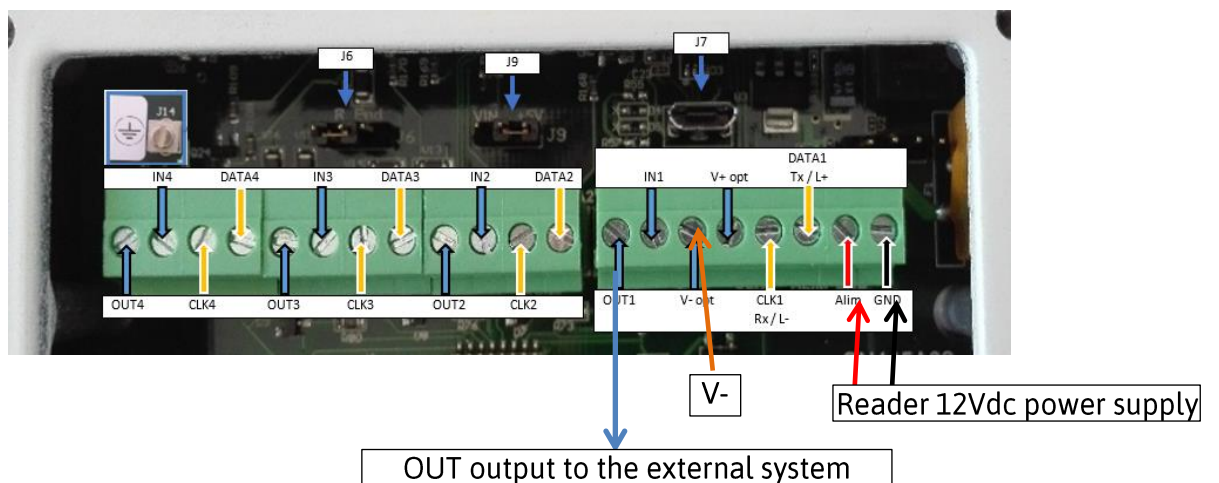

5.4 Example: reading activated when the presence of a vehicle is detected

5.4.1 ULTRYS v2 settings

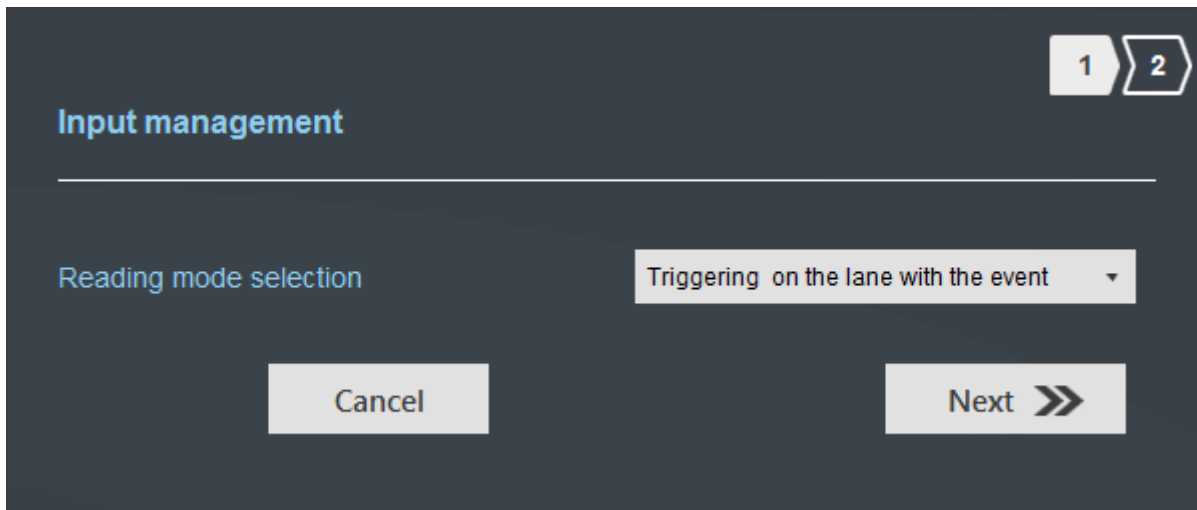

5.4.2 Connection

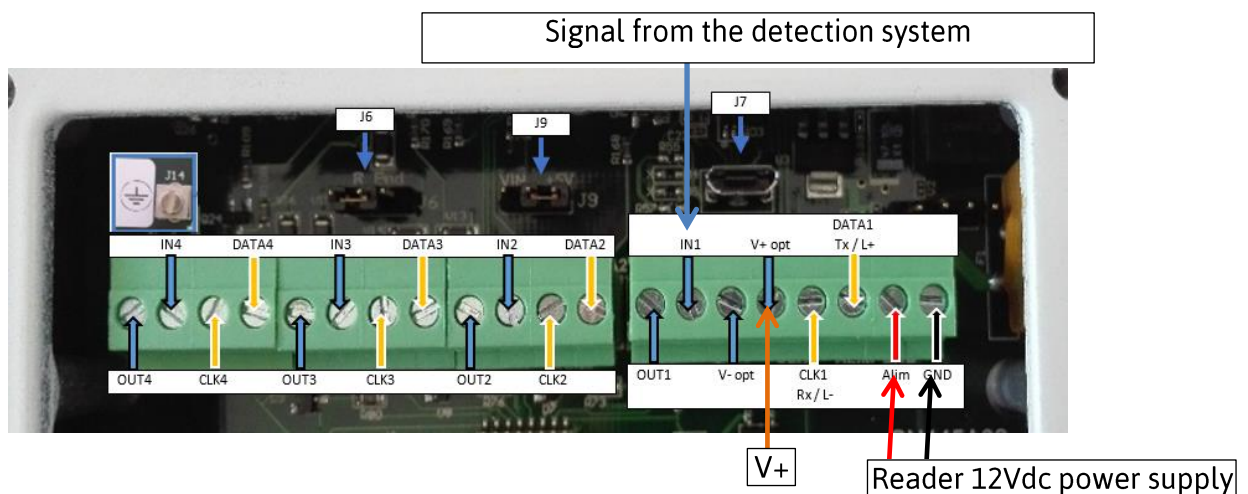

5.4.3 Operation

When the presence detection system detects a vehicle (e.g., ground loop, optical cell, etc.), the information is sent to the reader through the IN input of the corresponding channel (channel 1 in this example). The reader reads on this channel for as long as the input is active.

5.5 Example: Activation of an external optical warning

5.5.1 ULTRYS V2 settings

Input management 1 2

Reading mode selection Continuous reading

Managing custom events triggered by reader inputs

- No event
- Custom LED lighting
- Output customization

Cancel Next >>

Output management 1 2

Output type selection Pull up to V+

Status of outputs

	Open	Closed	Continuing during detection process
Output 1	<input checked="" type="radio"/>	<input type="radio"/>	<input type="checkbox"/>
Output 2	<input checked="" type="radio"/>	<input type="radio"/>	<input type="checkbox"/>
Output 3	<input checked="" type="radio"/>	<input type="radio"/>	<input type="checkbox"/>
Output 4	<input checked="" type="radio"/>	<input type="radio"/>	<input type="checkbox"/>

<< Previous Cancel Confirm

5.5.2 Connection

In this example, the optical warning operates at 24 Vdc.

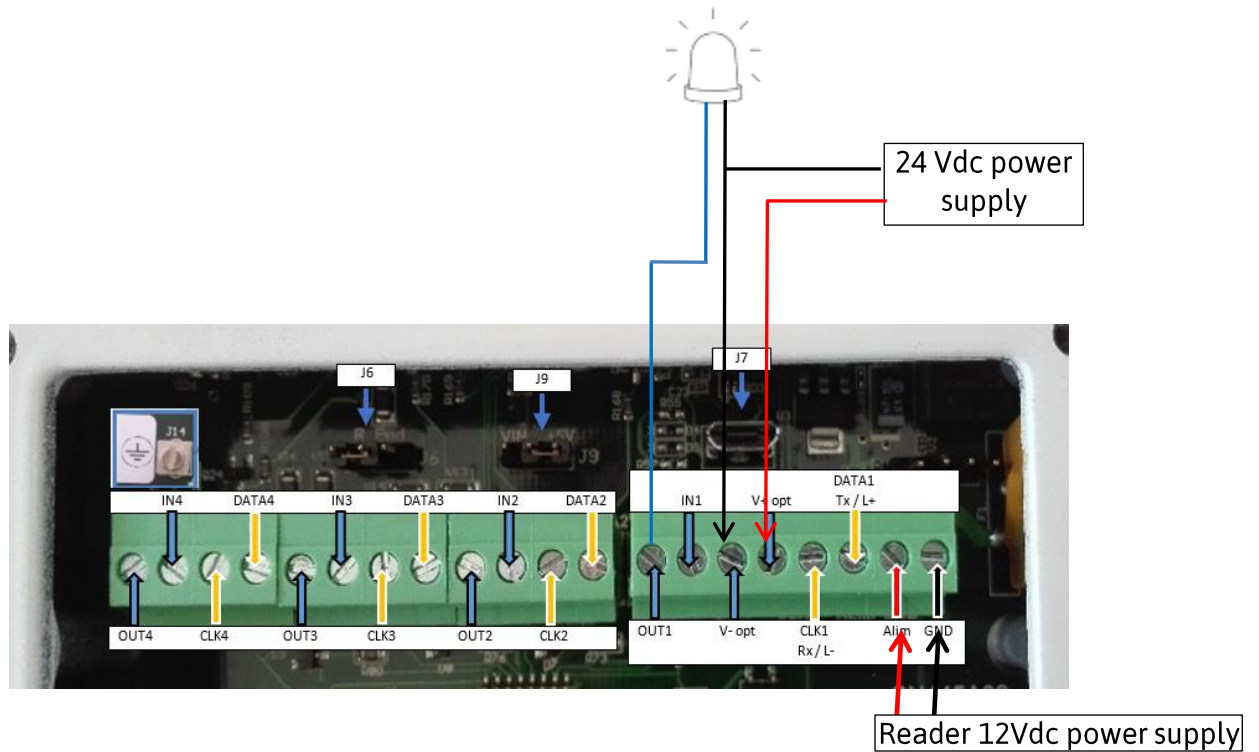

5.5.3 Operation

The reader reads continuously. When the reader sends a tag to the system on channel 1, the state of output 1 changes for 200 ms and returns to its normally open default position in this example.

6 Approach to projects

A number of steps must be followed when equipping a site with a SPECTRE Access configuration.

Site analysis

Collect the basic information required to define the configuration to be installed:

- Site map,
- Direction of the traffic flows,
- Dimensions,
- Types of vehicles to be identified.

Definition of the targets

Identification zones: choose the point where the vehicles are to be identified:

- Positions,
- Dimensions.

Choice of hardware

On the basis of the targets and restrictions identified in the preceding steps, the first hardware choices can be made (type of reader, number of readers, type of tag, etc.).

The technical options are determined by the constraints. This analysis produces a clear vision of the feasibility of the preferred configuration and any arrangements or compromises that may be necessary.

Definition of the tests

It is advisable to define the tests required to validate the configuration with the customer, if necessary, right from the outset. Make sure that representative vehicles (vehicles with athermic and non-athermic windshields) and the equipment required for the purposes of the validation are available.

7 Examples of configurations

Some conventional vehicle access configurations are described below, with an indication of the typical positions of the antennas/readers.

These configurations are just examples. They are generic and intended to provide food for thought. Certain functional factors may be influenced by external parameters.

7.1 One-lane single access



- An SLA reader is installed on the side.
- It is positioned before the barrier so that vehicles can be detected early enough.

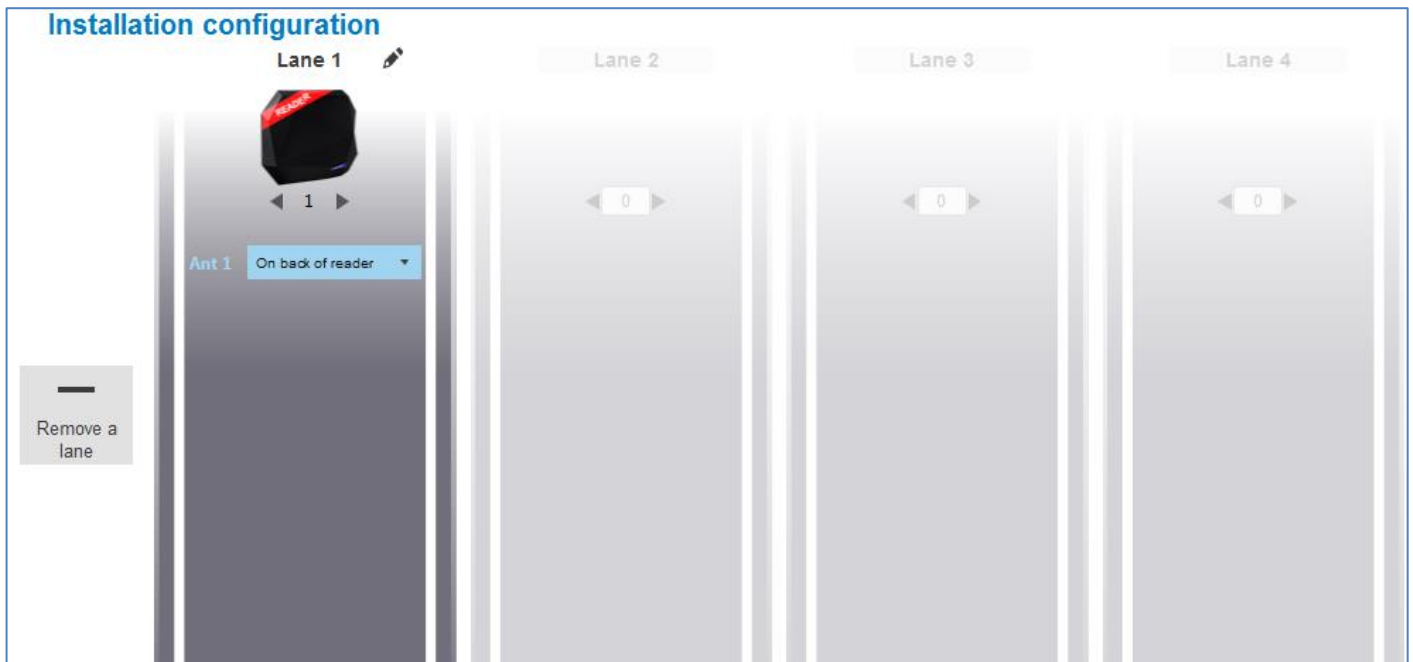

7.2 One-lane single access – Double height

When a single antenna is not sufficient to cover the entire height required to identify light vehicles and heavy goods vehicles.



SPECTRE

2 ANTENNAS CONFIGURATION



- One SLA reader and one SPECTRE antenna installed on the side.
- One 1.5m cable to connect the external antenna to the SLA reader.
- One antenna optimally positioned to detect light vehicles.
- One antenna optimally positioned to detect heavy goods vehicles.
- The reader is placed in front of the barrier in order to detect vehicles at a sufficient distance before the barrier.
- Both antennas are controlled by the same reader to avoid any risks of interference.

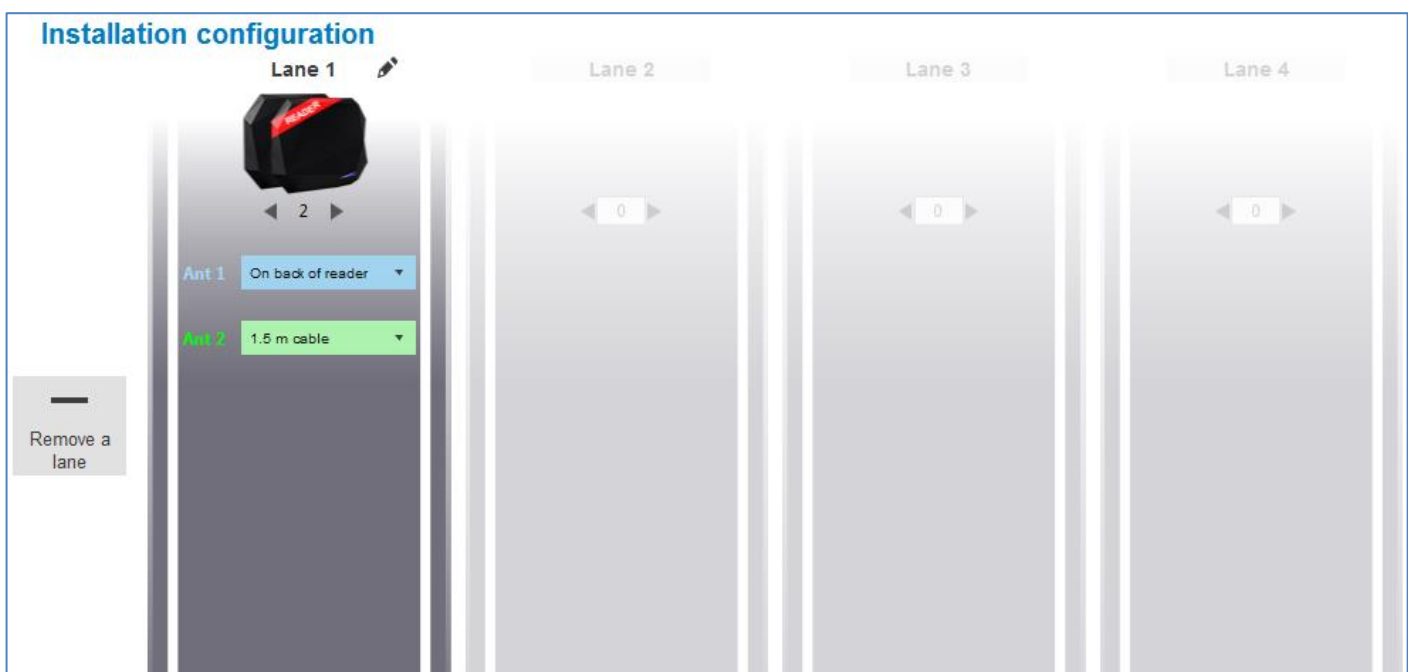

7.3 Single Entrance / Exit for light vehicles only with a central island

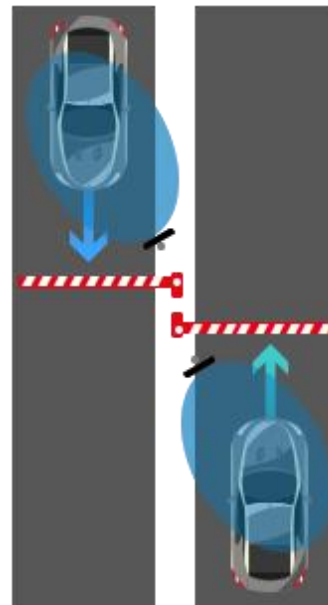

- One SLA reader and one SPECTRE antenna installed on the central island.
- One antenna cable to connect the external antenna to the SLA reader.
- One antenna installed to detect vehicles at the entrance.
- One antenna installed to detect vehicles at the exit.
- Each antenna monitors one lane and sends the data to its own specific reader output.
- The reader is placed in front of the barrier in order to detect vehicles at a sufficient distance before the barrier. This also limits the number of unwanted readings on another lane.
- Both antennas are controlled by the same reader to avoid any risks of interference.

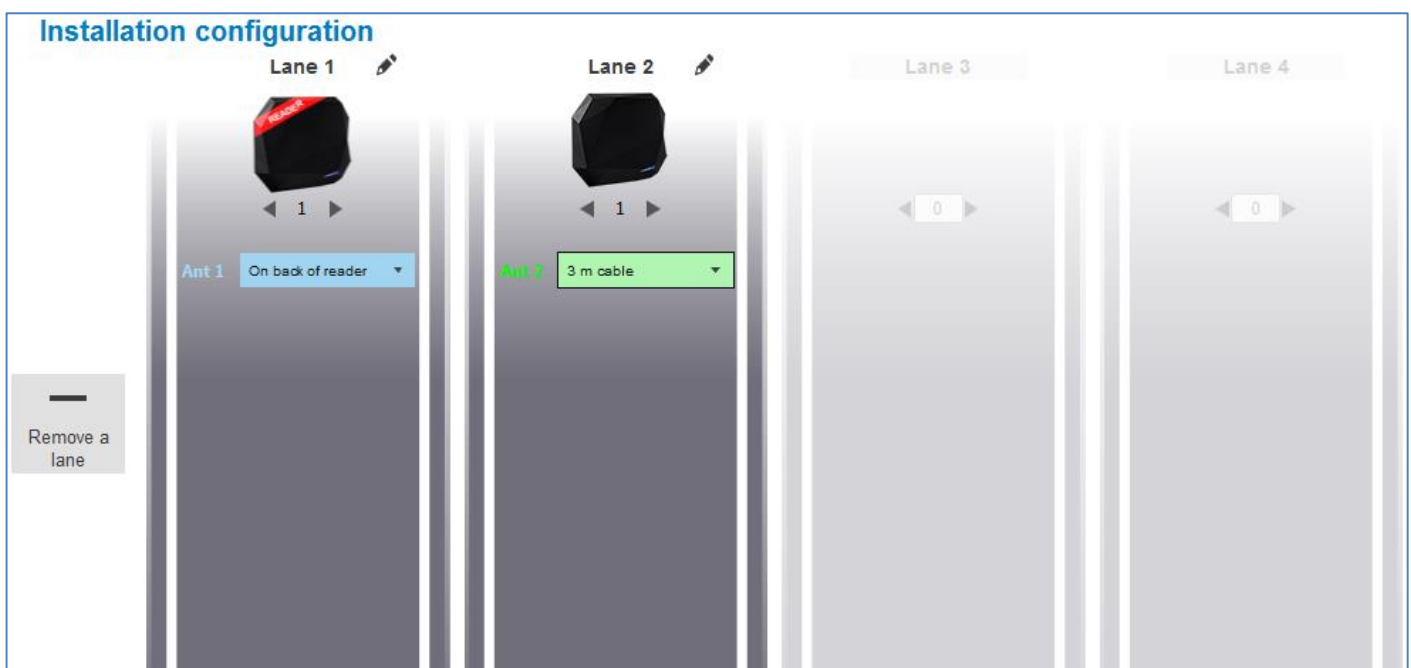

7.4 Double-width access on a two-way public road

Vehicles can arrive from both sides / sliding gate.

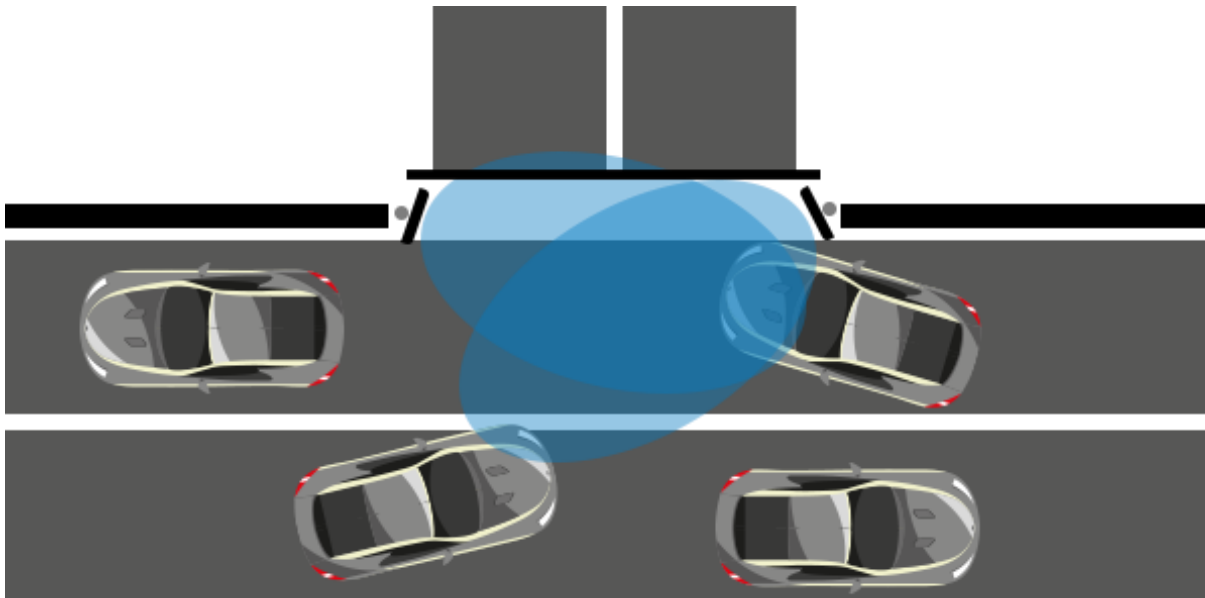

- SLA reader with a remote antenna, if an antenna cable can be routed.
- One antenna on each side of the gate in order to be in the axis of arriving vehicles.
- **Pay close attention to the width in order to remain in a zone covered by the reader.**

Installation configuration

Lane 1

◀ 2 ▶

Ant 1 On back of reader

Ant 2 12 m cable

Remove a lane

Lane 2

◀ 0 ▶

Lane 3

◀ 0 ▶

Lane 4

◀ 0 ▶

7.5 Multiple-lane access

One SMA reader with four remote antennas.



**SPECTRE
4 ANTENNAS CONFIGURATION**

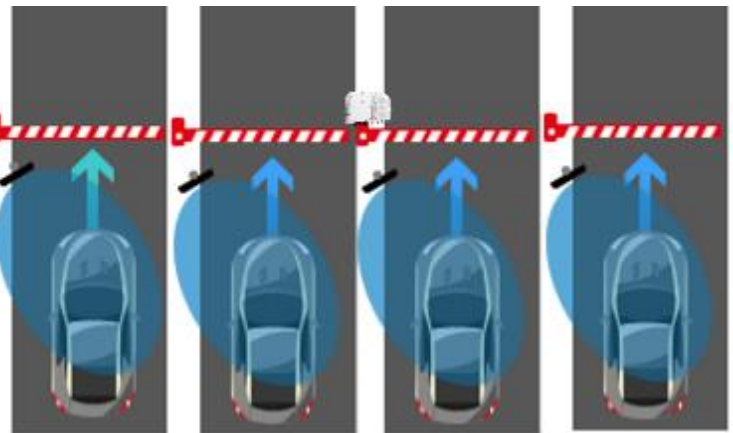

- The antennas are controlled by the same reader to avoid any risks of interference.
- Each antenna monitors one lane and sends the data to an independent output.
- The antennas can be installed up to 12m from the module, which is positioned in the center.

Installation configuration

Lane 1	Lane 2	Lane 3	Lane 4
 Ant 1	 Ant 2	 Ant 3	 Ant 4
On back of reader	6 m cable (2 x 3 m)	1.5 m cable	6 m cable (2 x 3 m)

Remove a lane

8 Installation methodology

- Position the tag inside the vehicle. **Do not hold the tag in your hand when validating**
- Put the vehicle in the typical / preferred identification zone.
- Adjust the height and direction of the antenna until a reading is obtained.
- Test the configuration with the vehicle in motion.
- Adjust the antenna until it produces an optimal result.

This configuration is optimized for the test vehicle. Ideally, these settings must also be configured using a vehicle that is very different from the first one (higher windshield, LCV, etc.) in order to install the antenna in a position covering as many use cases as possible.

9 Athermic windshields

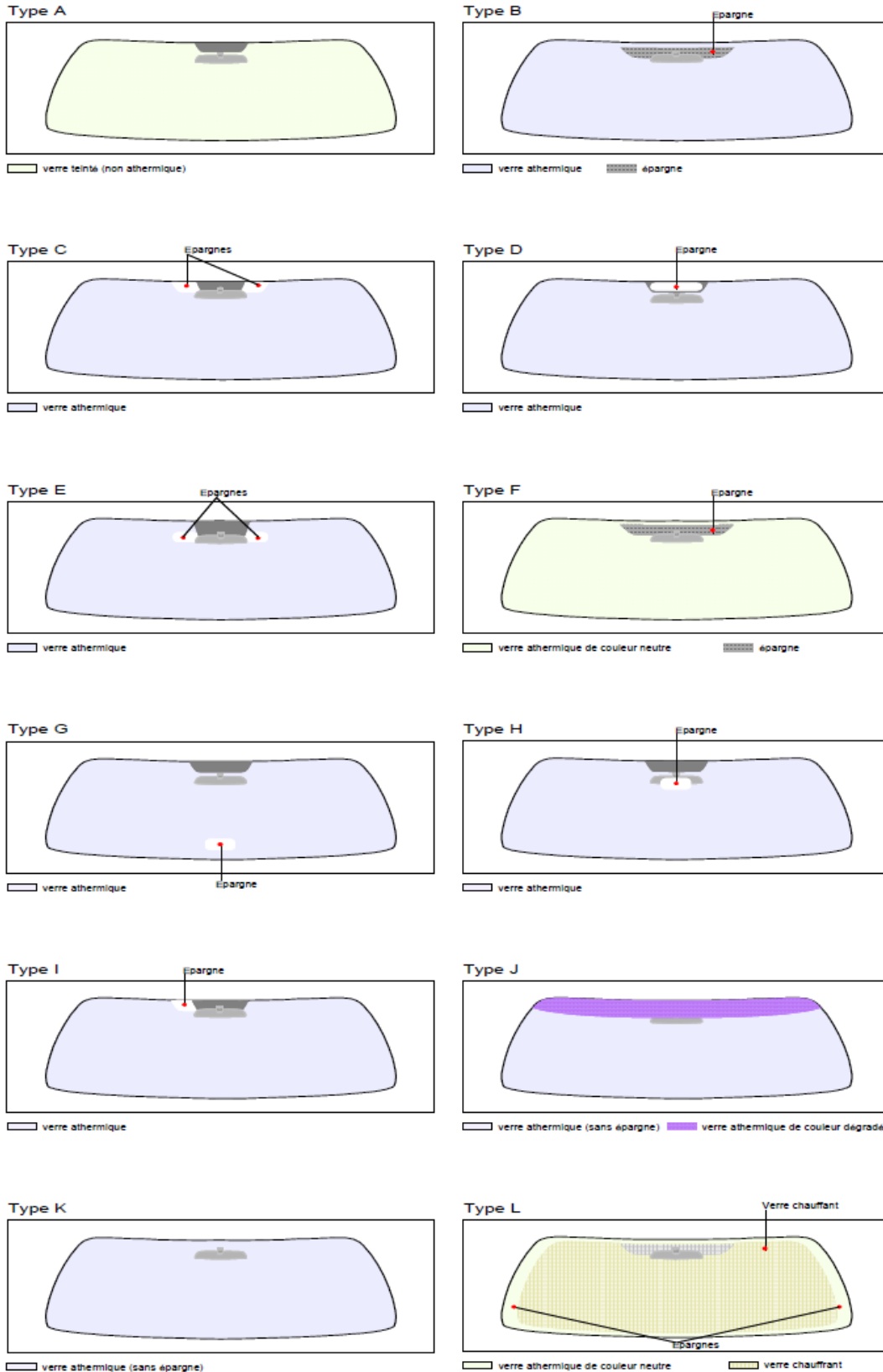

10 FAQ

Question	Cause	Recommendation
The red LED on the SMA flashes.	Power supply problem.	Check: <ul style="list-style-type: none"> - The maximum current supplied by the power supply. - The supply voltage in the reader. - the type of cable - the distance between the power supply and the reader.
My reader does not start up.	Insufficient voltage. Incorrect wiring.	Check the voltage at the terminals of the reader. Use a regulated power supply.
The red LED on the SMA flashes three times after every RF scan sequence.	RF connection problem with one or more cables and/or antennas.	Check: <ul style="list-style-type: none"> - the connections of the antenna cables. - the condition of the antenna cables.
The red LED on the SMA flashes five times after every RF scan sequence.	System temperature too high.	Install the SMA module in the shade.
No reading on one of the antennas, even over short distances.	Incorrect configuration of the channels.	Check the configuration (ground loop, EPC or RSSI filter) and the connections of the antennas to the channels.
My tag cannot be identified due to an athermic windshield.	The non-athermic section is incorrectly positioned or the reader is too far from the vehicle.	Position the tag correctly in the non-athermic section or change the position of the reader.
The vehicle does not have a non-athermic section.		Change the position or the type of the tag.

11 VERSION

Date	Version	Description
11/04/2019	1.0	New document.
18/06/2019	2.0	Addition of input / output management // Migration between the two ranges

info@stid.com
www.stid-security.com

Siège Social / EMEA
13850 Gréasque, France
Tél. : +33 (0)4 42 12 60 60

Agence PARIS-IDF
92290 Châtenay-Malabry, France
Tél. : +33 (0)1 43 50 11 43

STid UK Ltd. LONDRES
Hayes UB11 1FW, UK
Tél. : +44 (0) 192 621 7884

STid UK Ltd.
Gallows Hill, Warwick CV34 6UW, UK
Tél. : +44 (0) 192 621 7884

Agence AMÉRIQUE DU NORD
Irving, Texas 75063, USA
Tél. : +1 310 803 2114

Agence AMÉRIQUE LATINE
Cuauhtémoc 06600 CDMX, México
Tél. : +521 (55) 5256 4706

Agence AUSTRALIE / APAC
Ultimo, Sydney NSW 2007, Australie
Tél. : +61 (0)2 9274 8853